

DCM-PRO

The **only UL-Approved** Membrane System in North America

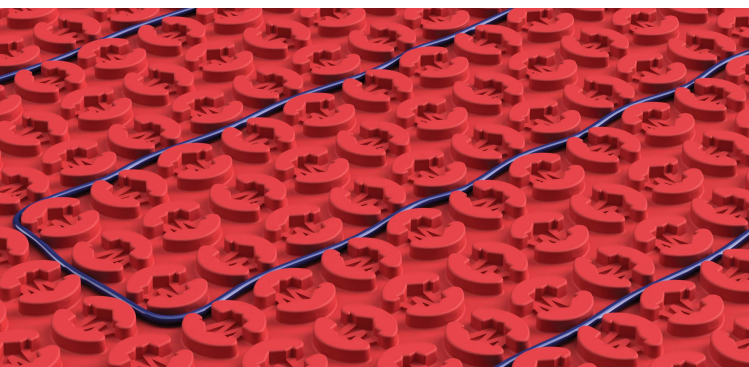

Installation Manual for
NADCM-C Series of Heaters

Technical Helpline

US: 1-888-927-6333

CA: 1-888-592-7687

IMPORTANT!

Please read this manual before attempting to install your Warmup product. Complete and submit your warranty form online at www.warmup.com or www.warmup.ca



Electric
Heating System

www.warmup.com
www.warmup.ca

Warmup[®]

The world's **best-selling** floor heating brand[™]

Over 2 million installations in more than 60 countries

Experience MyHeating[™]

Download now for iOS and Android



Unique to Warmup:



SmartGeo[™]

Smarter geo-fencing.
Reduce energy usage
by up to 25%



Easy to use

Simple and secure
set up

Natural Language Programming[™]

Programming that speaks your language



4iE[®] SMART WIFI THERMOSTAT

Quick Install Guide	4
Components Required for Installation.....	6
Do's & Don'ts	7
Step 1 - Electrical Supply	9
Step 2 - Subfloor Considerations.....	12
Step 3 - Subfloor Preparation	16
Alternate Installation - Fixing Strips.....	17
Step 4 - Lay DCM-PRO membrane	19
Step 5 - Layout Planning.....	20
Step 6 - Install DCM-PRO Cable.....	25
Step 7 - Select Floor Covering.....	27
Waterproofing	28
Step 8 - Lay the Floor Covering	30
Step 9 - Connect the Thermostat.....	32
Troubleshooting.....	33
Performance Troubleshooting.....	35
How to test the heater & floor sensor.....	37
Layout Plan	38
Control Card.....	39
Warranty.....	40
Technical Specifications	42

WARNING

Your Warmup® Underfloor heating system has been designed so that installation is quick and straight forward, but as with all electrical systems, certain procedures must be strictly followed. Please ensure that you have the correct heater(s) for the area you wish to heat. Warmup plc, the manufacturer of the Warmup® DCM-PRO System, accepts no liability, expressed or implied, for any loss or consequential damage suffered as a result of installations which in any way contravene the instructions that follow.

It is important that before, during and after installation that all requirements are met and understood. If the instructions are followed, you should have no problems. If you require help at any stage, please contact our helpline.

You may also find a copy of this manual, wiring instructions and other helpful information on our website:

www.warmup.com
www.warmup.ca



Quick Install Guide - The full installation instructions in this manual must be followed.



- 1 • Make electrical provision for the heater (4" x 4" x 2 3/4" deep UL/cUL certified electrical back boxes, conduit).

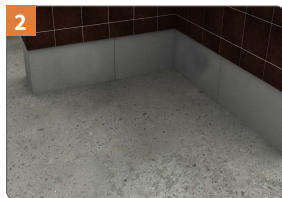

- 2 • Ensure the subfloor is smooth, dry and free from dust.



- 3 • We recommend installing Warmup insulation boards for optimum performance.
- Install perimeter strip around the perimeter of the room to allow for differential movement between finished floor level and walls.



- 4A • If installing DCM-PRO Fleece membrane apply a thinset layer to the substrate using a 1/4" x 1/4" square notch trowel.
- Cut the membrane to size and press into the thinset using a float or roller, removing any air pockets.
- Lay additional sheets as above ensuring that the pegs are aligned.

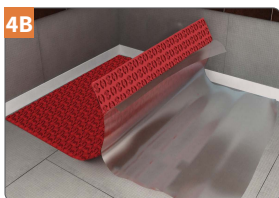

- 4B • If installing DCM-PRO Peel and Stick membrane an appropriate smoothing or levelling compound should be applied to coarse surfaces.
- Cut membrane to size, peel off backing and tack in place pressing down once aligned.
- Lay additional sheets as above ensuring that the pegs are aligned.

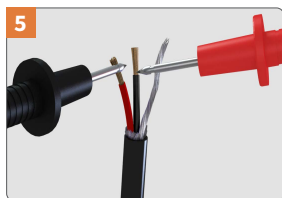

- 5 • Test the resistance of the heater ensuring it is within the range set out in the Reference Resistance Band table.

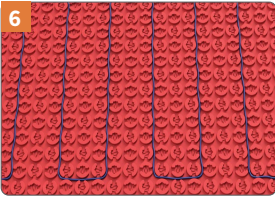

- Install the heating cable at the chosen spacing.
- Maintain a minimum 2 peg ($2 \frac{3}{8}$ ") perimeter spacing.

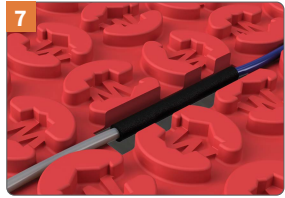

- Channel a groove in the membrane and subfloor for the coldtail & termination joints, enabling them to fit flush with the top of the membrane. DO NOT tape over these joints!
- Install the floor sensor centrally between two runs of the heater.

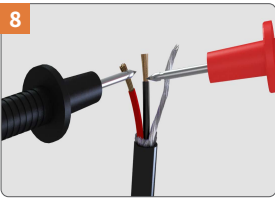

- Test the resistance of the heating cable after installation and check against the previous value to ensure no damage has occurred.



- Lay the tiles or levelling compound over the system
- The heater, including its joints, must be wholly within the thinset or levelling compound and not exposed.
- Use flexible grout when grouting.

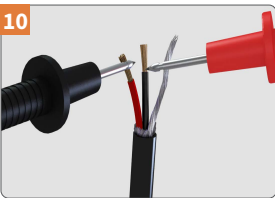

- Test the resistance of the heating cable after tiling and check against previous values to ensure no damage has occurred.



- Connect your Warmup thermostat.



Components available from Warmup

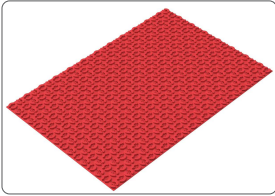

DCM-PRO Fleece membrane

(Fleece backed)

DCM-PRO Peel and Stick membrane

(Self-adhesive backing)

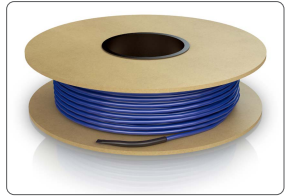

NADCM-C Cable



Warmup Insulation Boards



UL/cUL Certified Thermostat & Floor Sensor

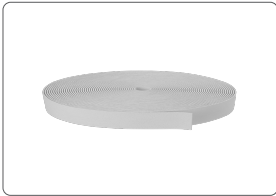

DCM-PRO Perimeter Strip

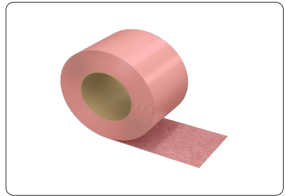

DCM-PRO Waterproofing Kit

Additional components needed as part of your Warmup heating installation:

















- Digital multi-meter required for testing the resistance of the heater and floor sensor.
- Electrical tape to secure the floor sensor.
- UL/cUL certified electrical housing, back boxes and junction boxes.
- UL/cUL certified electrical conduit for housing the power leads.
- Modified thinset & grout.



- ☑ Ensure that thinset used is compatible with underfloor heating and suitable for application with non porous materials such as the DCM-PRO membrane.
- ☑ Maintain a spacing that produces no more than 16 W/ft² of heat input into the floor.
- ☑ Make sure all electrical work is done by qualified persons in accordance with local building and electrical codes, the National Electrical Code (NEC), especially article 424, Part V of the NEC, ANSI/NFPA 70, for the US and Canadian Electrical Code, Part 1, for Canada.
- ☑ Check the resistance of the heater before, during, and after installation to ensure that no damage has occurred. A tolerance of +/- 5% is allowed.
- ☑ Make sure the heater is connected to a UL/cUL certified GFCI controller or breaker where required by code.
- ☑ Plan the heating system layout and installation so that any drilling after tiling (e.g. for fixtures such as vanity units, tubs) will not damage the wiring. Remember to keep a copy for future reference.
- ☑ Ensure that the heater is at least 8" from other heat sources such as luminaires and chimneys.
- ☑ Ensure that the minimum free bending radius of the heater is not less than 1".
- ☑ Ensure the subfloor is fully cured and stable before commencing installation of the heater.
- ☑ Ensure that each tile is solidly bedded in thinset, with no gaps or voids beneath.
- ☑ Make sure that the heater, including manufactured joints are positioned under the final floor finish and completely embedded in thinset.
- ☑ Install the floor probe for the thermostat. It should be installed centrally between two heating element runs. Ensure that the sensor does not touch or cross over the heater.
- ☑ Ensure that you have electrical provisions to run the heating system at 120 V AC or 240 V AC according to the system being installed.
- ☑ Check the wattage and voltage of the heater to ensure you have the correct system for your application.
- ☑ Ensure any parallel runs of cold tail and sensor wire are kept separated within the wall, using UL/cUL certified conduit where required.
- ☑ Make sure that the system is fully grounded following the wiring instructions provided.
- ☑ Use a separate cable for the shower area.
- ☑ Indicate which circuits supply power to the heater on the circuit breaker. Attach the product labels for each heater to the circuit breaker, for future reference.



DON'T

-  Cross the cable over another run, over coldtails or the floor sensor. This will cause overheating and will damage the cable.
-  Cut or shorten the heater at any time.
-  Install parallel runs of heating cable closer than 3" if using cable fixing strips or 2 pegs (2 3/8") if using the DCM-PRO membrane. Refer to the Layout Planning page for further guidance.
-  Install the heater with staples or other metal fixings that can cause damage.
-  Store tiles, sharp or heavy objects on top of the heater.
-  Install the heater below 5°F (-15°C) ambient temperature.
-  Attempt to bypass the GFCI if it trips and cannot be reset during normal operation. Consult a qualified electrician or call the helpline for further assistance.
-  Install the heater under permanent fixtures or in closets.
-  Commence installation on a screed that has not been fully cured.
-  Cover the cold lead or termination joint with tape. This may cause air pockets resulting in the joints overheating.
-  Install the heater beyond the room or area in which they originate.
-  Attempt to repair the heater if it is damaged. Call the technical helpline for further instructions.
-  Allow the thermostat to exceed the maximum temperature for your final floor finish. Always check the maximum temperatures allowed with the floor covering manufacturer.
-  Switch on the installed heater until thinset has fully cured, check manufacturer's instructions.
-  Install the heating cable closer than 2" from the wall, partitions and permanently fixed objects
-  Store the DCM-PRO Peel and Stick membrane in direct sunlight. Prolonged exposure to UV radiation will alter the properties of the adhesive backing, voiding the product warranty.

WARNING : "RISK OF ELECTRIC SHOCK AND FIRE".

Damage to supply conductor insulation may occur if conductors are routed less than 2" from this heating product.

CAUTION: a ground fault protection device must be used with this heating device",

"ATTENTION : ce produit doit être utilisé avec une protection de mise à la terre", unless exempted by the Canadian Electrical Code, Part I.

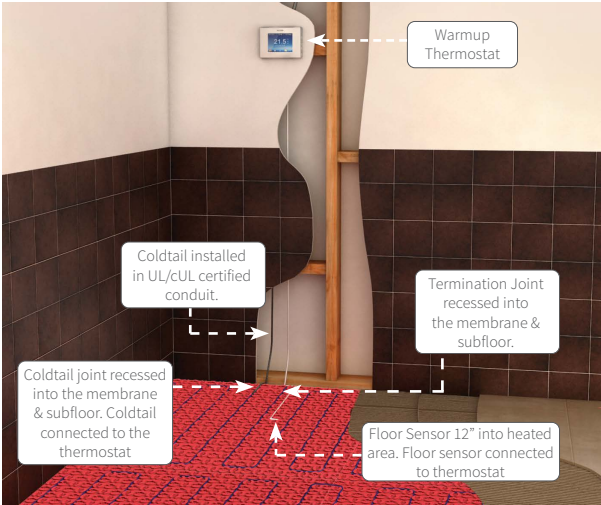

The installation of electrical systems presents risks of fire and electrical shock which can result in personal injury. All electrical connections should be carried out by a qualified electrician in accordance with the National Electrical Code and all local Codes. For installations in Canada, refer to relevant sections in the CEC.

The heater **MUST** be connected to the electrical system through a UL/cUL certified Ground Fault Circuit Interrupter ("GFCI"). If you are not using a thermostat with an integral GFCI, ensure that the branch circuit supplying your heaters is GFCI protected and if possible, use a dedicated GFCI protected circuit to supply each heated zone. This requirement is critical to the safe operation of the heater.

For smaller areas, you may be able to utilize an existing circuit. In most cases, however, you will need a separate dedicated circuit to power the Warmup heating cables.

NOTE: The power leads must be protected where they leave the floor by a suitable UL/cUL certified conduit.

NOTE: A UL/cUL certified junction box is required if more than two heaters are being installed.

NOTE: If conducting an insulation resistance test on the supply to the thermostat, the thermostat and heaters must be isolated or disconnected. This is to prevent the thermostat and heater(s) from being exposed to test voltages that exceed its specified limit.



Typical Wiring Diagram 120V

Typical Wiring for a GFCI Thermostat

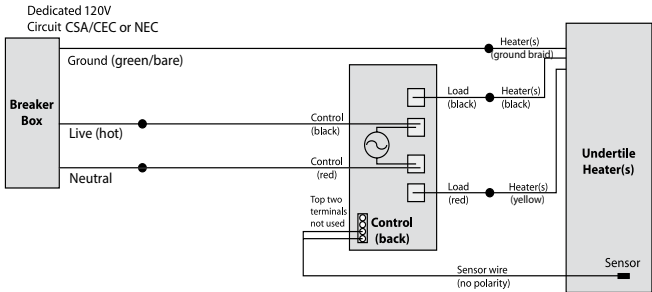

Typical Wiring for a Thermostat Control and Contactor

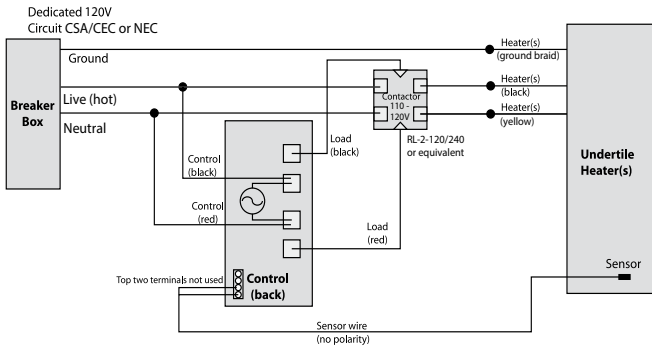

NOTE: All electrical work must be performed by a qualified electrician in accordance with local building & electrical codes and the Canadian Electrical Code, part 1 in Canada or the National Electrical Code in the USA, especially Article 424, Part V of the NEC ANSI/NFPA 70.

Undertile heaters are to be installed in parallel across the load terminals of the thermostat or contactor and must not exceed their rated load.

Typical Wiring Diagram 240V

Typical Wiring for a Thermostat GFCI Control

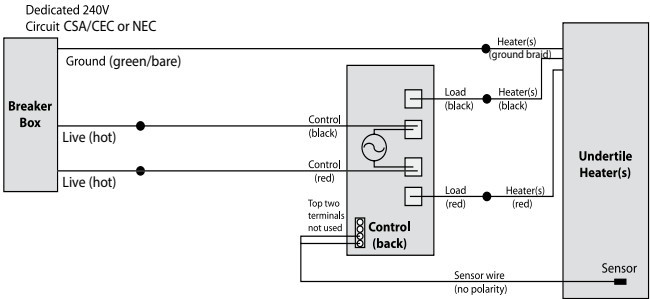

Typical Wiring for a Thermostat Control and Contactor

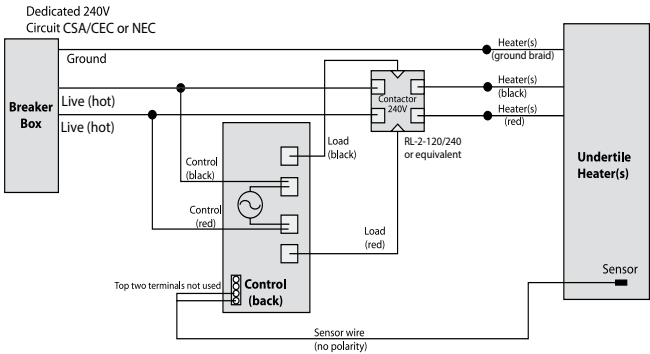

NOTE: All electrical work must be performed by a qualified electrician in accordance with local building & electrical codes and the Canadian Electrical Code, part 1 in Canada or the National Electrical Code in the USA, especially Article 424, Part V of the NEC ANSI/NFPA 70.

Undertile heaters are to be installed in parallel across the load terminals of the thermostat or contactor and must not exceed their rated load.

NOTE: When installing the heater in kitchens or bathrooms it must be protected by a UL/cUL certified GFCI. If the heater is switched by a separate contactor its supply must be GFCI protected. To prevent nuisance tripping a thermostat with integral GFCI protection should not be supplied by a GFCI protected circuit.



Subfloor Preparation

Subfloors previously covered in vinyl, cork or carpeting: all old flooring and glues must be removed.

Any materials on or within the subfloor must be suitable for supporting eUFH systems. If using temperature sensitive materials beneath the eUFH system, such as damp proofing or tanking systems, contact the manufacturer for advice.

DCM-PRO Concrete Subfloors

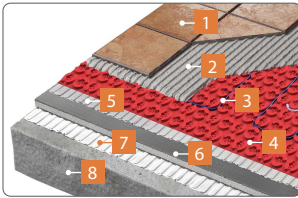

CONCRETE SUBFLOOR (Recommended)

- 1 Floor Finish
- 2 1/4" Minimum Thinset or 3/8" levelling compound*
- 3 Warmup DCM-PRO Cable
- 4 Warmup DCM-PRO Fleece membrane
- 5 Thinset layer applied with 1/4" x 1/4" square notch trowel or 1/8" levelling compound**
- 6 Warmup Insulation Board
- 7 1/4" Minimum Thinset
- 8 Subfloor

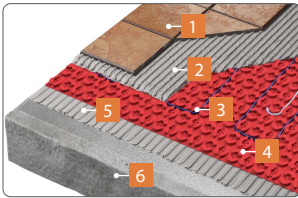

CONCRETE SUBFLOOR

- 1 Floor Finish
- 2 1/4" Minimum Thinset or 3/8" levelling compound*
- 3 Warmup DCM-PRO Cable
- 4 Warmup DCM-PRO Fleece membrane
- 5 Thinset layer applied with 1/4" x 1/4" square notch trowel or 1/8" levelling compound**
- 6 Subfloor

For optimum performance it is recommended that you use Warmup® Insulation Boards beneath Warmup DCM-PRO. The insulation will improve the systems response to heating demand, saving energy and reducing running costs.

Where expansion joints are present in the subfloor, these must be preserved up through all covering layers, including insulation where installed and DCM-PRO.

* 1/4" Minimum thinset or 3/8" levelling compound layer is measured from the top of the DCM-PRO membrane. The levelling compound, when used, must be applied as a single layer. Additional layers of levelling compound must not be added.

** The thinset layer is only required when installing DCM-PRO Fleece membrane. 1/8" levelling compound is required when installing DCM-PRO Peel and Stick membrane. If the surface the DCM-PRO Peel and Stick membrane is being applied to is smooth such that a continuous bond can be made this layer of levelling compound is not required.

In addition to the general subfloor preparation instructions on the previous page, wood subfloors should be prepared for tiling in accordance with local tiling standards such as ANSI A108 series.

Wood Subfloors

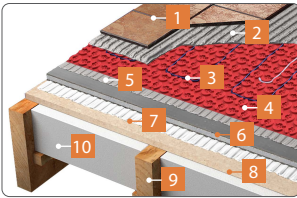

WOOD SUBFLOOR (Recommended)

- 1 Floor Finish
- 2 1/4" Minimum Thinset or 3/8" levelling compound*
- 3 Warmup DCM-PRO Cable
- 4 Warmup DCM-PRO Fleece membrane
- 5 Thinset layer applied with 1/4" x 1/4" square notch trowel or 1/8" levelling compound**
- 6 Warmup Insulation Board
- 7 1/4" Minimum Thinset
- 8 Floor Deck
- 9 Joists
- 10 Insulation

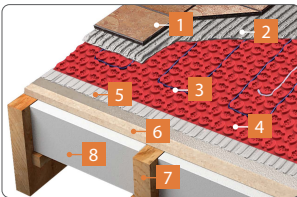

WOOD SUBFLOOR

- 1 Floor Finish
- 2 1/4" Minimum Thinset or levelling compound*
- 3 Warmup DCM-PRO Cable
- 4 Warmup DCM-PRO Fleece membrane
- 5 Thinset layer applied with 1/4" x 1/4" square notch trowel or 1/8" levelling compound**
- 6 Floor Deck
- 7 Joists
- 8 Insulation

* 1/4" Minimum thinset or 3/8" levelling compound layer is measured from the top of the DCM-PRO membrane. The levelling compound, when used, must be applied as a single layer. Additional layers of levelling compound must not be added.

** The thinset layer is only required when installing DCM-PRO Fleece membrane. 1/8" levelling compound is required when installing DCM-PRO Peel and Stick membrane. If the surface the DCM-PRO Peel and Stick membrane is being applied to is smooth such that a continuous bond can be made this layer of levelling compound is not required.



Fixing Strips Concrete Subfloors

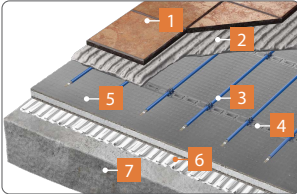

CONCRETE SUBFLOOR (Recommended)

- 1 Floor Finish
- 2 $\frac{3}{8}$ " Minimum Thinset or levelling compound
- 3 Warmup DCM-PRO Cable
- 4 Warmup Fixing Strips
- 5 Warmup Insulation Board
- 6 $\frac{1}{4}$ " Minimum Thinset
- 7 Subfloor

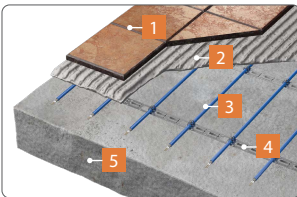

CONCRETE SUBFLOOR

- 1 Floor Finish
- 2 $\frac{3}{8}$ " Minimum Thinset or levelling compound
- 3 Warmup DCM-PRO Cable
- 4 Warmup Fixing Strips
- 5 Subfloor

Wood Subfloors

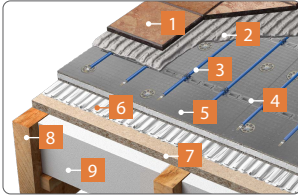

WOOD SUBFLOOR (Recommended)

- 1 Floor Finish
- 2 $\frac{3}{8}$ " Minimum Thinset or levelling compound
- 3 Warmup DCM-PRO Cable
- 4 Warmup Fixing Strips
- 5 Warmup Insulation Board
- 6 $\frac{1}{4}$ " Minimum Thinset
- 7 Floor Deck
- 8 Joists
- 9 Insulation

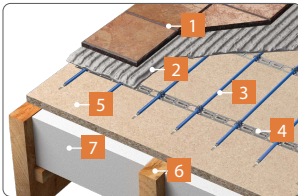

WOOD SUBFLOOR

- 1 Floor Finish
- 2 $\frac{3}{8}$ " Minimum Thinset or levelling compound
- 3 Warmup DCM-PRO Cable
- 4 Warmup Fixing Strips
- 5 Floor Deck
- 6 Joists
- 7 Insulation



- Ensure the subfloor is dry and smooth. If necessary an appropriate smoothing or levelling compound should be applied.



- If required, prime wood or sand and cement screeded subfloors with a non-latex acrylic primer. For proprietary subfloors refer to the manufacturers instructions.

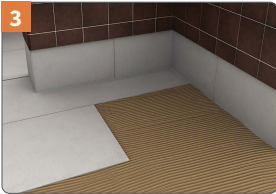

- **Recommended Step** - Install Warmup® insulation boards over the subfloor referring to their installation instructions.

Warmup insulation boards are made of extruded polystyrene, faced on both sides with a fibreglass mesh embedded into a thin cement polymer mortar. They will help reduce the heat up times of your system for optimal performance.



- Install perimeter expansion strips within the DCM-PRO system, along any perimeter or sectional expansion joints within the subfloor to preserve their function. Remove the tape from the perimeter strip to expose the adhesive back and begin pressing it into the wall, ensuring the strip also touches the floor.

Installing the perimeter strip allows for differential movement between the finished floor level and walls.

IMPORTANT: When installing DCM-PRO Peel and Stick membrane the surface the membrane is being applied to must be primed and smooth, such that a clean and continuous bond can be made. If necessary an appropriate $\frac{1}{8}$ " levelling compound should be applied. Coarse and/or loose subfloor surfaces will prevent the membrane from forming a continuous bond. For example; cement coated insulation boards with a raised pattern must have a levelling compound applied over.

When using the fixing strips to secure the cable to the subfloor, use the following provisions to ensure proper spacing of the cable.

The fixing strips should be installed a minimum of 3" away from the wall perpendicular to the planned cable runs. Additional fixing strips should be installed at intervals 3-4 ft apart across the floor. The fixing strips can be secured to the floor using suitable adhesive, nails, screws or strong double-sided tape.

Once you have secured the fixing strips, the heating cable may be laid out.

Installing the heating cable

Before you start laying the underfloor heating cable, ensure that the heating cable(s) are tested. After 10 feet of cable has been removed, you will reach the point at which the unheated lead joins the heating cable.

The factory made joint should be taped to the floor before and after the joint. DO NOT tape over this joint as this may create air pockets resulting in failure of the joint. Ensure that the factory joint lays flat on the floor. The joint must be installed under the floor covering and covered with $\frac{3}{8}$ " thinset or self-levelling underlayment from the top of the floor deck. A channel will need to be made into the floor deck to accommodate the extra height of the joint. Care should be taken to ensure that the joint is not bent.

Under no circumstances should the joint or the heated wire be installed within the conduit, only the cold tail should occupy the UL/cUL certified conduit.

Install the heating cable as per the installation plan. The heating cable should be laid in parallel lines back and forth across the main body of the area to be heated. Use the spacing guide in the Layout Planning page to space the cable.

The standard (UL-Approved minimum) spacing is 3" if using cable fixing strips.

Ensure that the cable is held in place by the fixing strips and that you maintain moderate tension on the cable to prevent it from lifting during the installation of the final floor covering.

Using duct tape, secure the end of the cable to the floor ensuring no air pockets. DO NOT cover the factory end joint in tape as air pockets may cause the end joint to overheat.



Installing the floor sensor

The floor sensor is used for temperature regulation of the floor surface. The end of the probe wire contains a capped sensor that should be centred between two heating cables at least 12" into the heated area.

The sensor wire **MUST NOT** touch or cross over the heating cables. Depending on the requirements of the tiler, it may be necessary to chisel out short channels in the subfloor to minimize the increased height presented by the floor probe. Before chiseling the area, ensure that the heating cable, unheated lead and floor probe are protected to avoid damage during chiseling. Place the floor probe into the channels and secure with fixing tape.

IMPORTANT! DO NOT tape over the floor sensor tip.

NOTE: DO NOT run the cold lead wires and the floor sensor in the same UL/cUL certified conduit.

IMPORTANT - Test the cable and floor sensor

Before installing the final floor finish ensure that the cable(s) and floor sensor is working properly using the method described on the "How to test the heater & floor sensor" page.



- Measure and cut a length of membrane to suit your room using a utility knife and/or scissors.

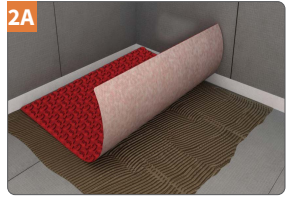

- If installing DCM-PRO Fleece membrane apply a thinset layer to the substrate using a 1/4" x 1/4" square notch trowel.
- Position the membrane, fleece side down into the thinset.
- Embed the membrane into the thinset using a float/roller removing any air pockets.

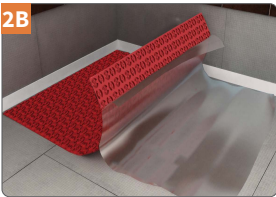

- If installing DCM-PRO Peel and Stick membrane, position the membrane and remove the backing from one edge/corner and stick in position before removing the rest of the backing.

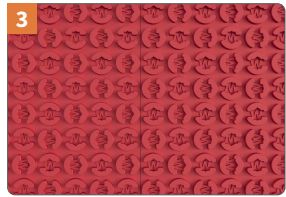

- Repeat previous steps for subsequent runs of the membrane, butting the runs of membrane together tightly until the floor area is covered, making sure to align the pegs between membrane runs.
- Protect the membrane with walking boards in areas of high foot traffic and under heavy loads.

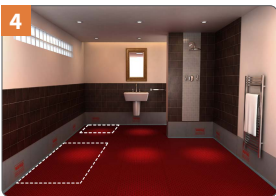

- Mark out the floor with a permanent marker showing where fixtures and other unheated areas are going to be.



A plan of the cable layout is required as part of the control card so that any cutting or drilling after tiling will not result in injury or damage to the heater.

Before you begin

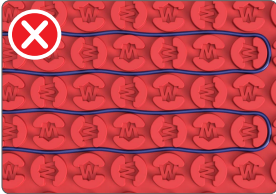

- The standard (UL-Approved minimum) spacing is 3 pegs ($3 \frac{5}{8}$ ") between parallel heating cables.
- DO NOT install parallel runs of heating cable closer than 3" if using cable fixing strips or 2 pegs ($2 \frac{3}{8}$ ") if using the DCM-PRO membrane.

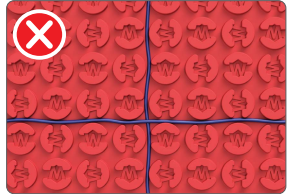

- When installing the cable **DO NOT** cross the cable over another run, over coldtails or the floor sensor. This will cause overheating and will damage the cable.

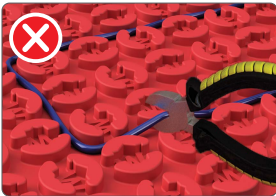

- The heating cable must not be cut, shortened, extended or left in a void, it must be fully installed within the layer of thinset or levelling compound.

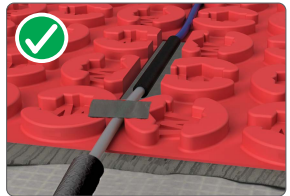

- Heating cables cannot be installed across expansion joints within the floor. Where a heated floor is divided by expansion joints, individual cables should be used to heat each area. The cold tail may cross the expansion joint within a 12" long UL/cUL certified conduit if necessary.

NOTE: The heater should not be installed on irregular surfaces such as stairs or up walls.

NOTE: Ensure the heating cable is at least 8" away from the influence of other heat sources, such as heating and hot water pipes, lighting fixtures or chimneys at all times.

DCM-PRO Peg Spacing Diagrams

At a 3 peg spacing the specific heat load of the DCM-PRO system is $\sim 13 \text{ W/ft}^2$. By adjusting the cable spacing, the installation can be customized to suit both the floor coverage and heat load requirements.

When installing the cable using the DCM-PRO membrane, maintain a 2 peg ($2 \frac{3}{8}$ ") perimeter spacing, between itself and the perimeter or any unheated areas.

2-3 Peg (~ 3 ") Spacing $\sim 16 \text{ W/ft}^2$



Primarily used in areas requiring a rapid heat-up time. The higher heater power will not necessarily lead to more heat output, just a faster heat-up.

3 Peg ($3 \frac{5}{8}$ ") Spacing $\sim 13 \text{ W/ft}^2$



This is the standard (UL-Approved minimum) spacing and works best for most projects. It has enough excess power to heat-up quickly, but uses less wire and is more economical.

3-4 Peg ($\sim 4 \frac{1}{4}$ ") Spacing $\sim 11 \text{ W/ft}^2$



4 Peg ($4 \frac{7}{8}$ ") Spacing $\sim 10 \text{ W/ft}^2$



3-4 or 4 peg spacings are primarily used in areas with lower heat-loss, such as well-insulated homes (Passive Houses). With these lower outputs, it is important to consider the flooring choice so as to reduce the chance of striping (often if the flooring is too thin).

Warmup NADCM-C cables are UL certified or listed to the following standards and usage: (File: E303230)

- UL 1683 "Electric Heating Products For Installation Under Floor Coverings".
- CAN/CSA-C22.2 No. 130-16 "Requirements for Electrical Resistance Trace Heating and Heating Device Sets".

Where peg spacings of 3, 3-4 and 4 are used, the UL certification applies to the **entire system**, including the membrane.



DCM-PRO - 120 Volt Spacing Guide

PRODUCT CODE	Cable length (ft)	Peg Spacings & Areas Covered (ft ²)			
		2-3 Pegs (~ 3")	3 Pegs (3 ⁵ / ₈ ")	3-4 Pegs (~ 4 ¹ / ₄ ")	4 Pegs (4 ⁷ / ₈ ")
		~16 W/ft ²	~13 W/ft ²	~11 W/ft ²	~10 W/ft ²
NADCM-C-120-65	16.7	4	5	6	7
NADCM-C-120-130	33.1	8	10	12	13
NADCM-C-120-195	49.9	13	15	18	20
NADCM-C-120-260	66.3	17	20	23	27
NADCM-C-120-325	83.0	21	25	29	33
NADCM-C-120-390	99.4	25	30	35	40
NADCM-C-120-525	132.8	33	40	47	53
NADCM-C-120-655	166.0	42	50	58	67
NADCM-C-120-785	199.1	50	60	70	80
NADCM-C-120-920	232.2	58	70	82	93
NADCM-C-120-1050	265.4	67	80	93	107
NADCM-C-120-1180	298.5	75	90	105	120
NADCM-C-120-1315	331.6	83	100	117	133
NADCM-C-120-1445	364.7	91	110	128	146
NADCM-C-120-1575	397.9	100	120	140	160

DCM-PRO - 240 Volt Spacing Guide

PRODUCT CODE	Cable length (ft)	Peg Spacings & Areas Covered (ft ²)			
		2-3 Pegs (3")	3 Pegs (3 ⁵ / ₈ ")	3-4 Pegs (4 ¹ / ₄ ")	4 Pegs (4 ⁷ / ₈ ")
		~16 W/ft ²	~13 W/ft ²	~11 W/ft ²	~10 W/ft ²
NADCM-C-240-195	50.0	13	15	18	20
NADCM-C-240-325	83.0	21	25	29	33
NADCM-C-240-390	99.4	25	30	35	40
NADCM-C-240-525	132.8	33	40	47	53
NADCM-C-240-655	166.0	42	50	58	67
NADCM-C-240-785	199.1	50	60	70	80
NADCM-C-240-920	232.2	58	70	82	93
NADCM-C-240-1050	265.4	67	80	93	107
NADCM-C-240-1180	298.5	75	90	105	120
NADCM-C-240-1310	331.6	83	100	117	133
NADCM-C-240-1640	414.6	104	125	146	167
NADCM-C-240-1970	497.6	125	150	175	200
NADCM-C-240-2300	580.6	146	175	204	233
NADCM-C-240-2630	663.2	166	200	233	266
NADCM-C-240-2955	746.2	187	224	262	300
NADCM-C-240-3240	829.2	208	249	292	333

NOTE: All peg spacings in the tables above are covered by the standard Warmup Warranty as detailed at the end of this manual.

Fixing Strip - 120 Volt Spacing Guide

PRODUCT CODE	Cable Length (ft)	Peg Spacings & Areas Covered (ft ²)	
		3"	4"
		16 W/ft ²	12 W/ft ²
NADCM-C-120-65	16.7	4	6
NADCM-C-120-130	33.1	8	11
NADCM-C-120-195	49.9	12	17
NADCM-C-120-260	66.3	17	22
NADCM-C-120-325	83.0	21	28
NADCM-C-120-390	99.4	25	33
NADCM-C-120-525	132.8	33	44
NADCM-C-120-655	166.0	42	55
NADCM-C-120-785	199.1	50	66
NADCM-C-120-920	232.2	58	77
NADCM-C-120-1050	265.4	66	88
NADCM-C-120-1180	298.5	75	100
NADCM-C-120-1315	331.6	83	111
NADCM-C-120-1445	364.7	91	122
NADCM-C-120-1575	397.9	99	133

Fixing Strip - 240 Volt Spacing Guide

PRODUCT CODE	Cable Length (ft)	Peg Spacings & Areas Covered (ft ²)	
		3"	4"
		16 W/ft ²	12 W/ft ²
NADCM-C-240-195	50.0	13	17
NADCM-C-240-325	83.0	21	28
NADCM-C-240-390	99.4	25	33
NADCM-C-240-525	132.8	33	44
NADCM-C-240-655	166.0	42	55
NADCM-C-240-785	199.1	50	66
NADCM-C-240-920	232.2	58	77
NADCM-C-240-1050	265.4	66	88
NADCM-C-240-1180	298.5	75	100
NADCM-C-240-1310	331.6	83	111
NADCM-C-240-1640	414.6	104	138
NADCM-C-240-1970	497.6	124	166
NADCM-C-240-2300	580.6	145	194
NADCM-C-240-2630	663.2	166	221
NADCM-C-240-2955	746.2	187	249
NADCM-C-240-3240	829.2	207	276

NOTE: When installing the cable using fixing strips, maintain a minimum 2" perimeter spacing between itself and the perimeter or any unheated areas.

The standard (UL-Approved minimum) cable to cable spacing when using fixing strips is 3".



Layout Planning Notes

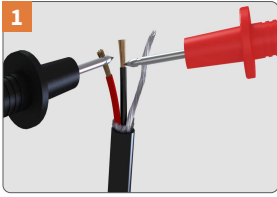

- Measure and record the resistance of the heating cable in the “Resistance Before” column of the control card, supplied as part of this installation guide.
- Stop installation immediately and contact Warmup if its resistance falls outside the range set out in the Reference Resistance Band table.

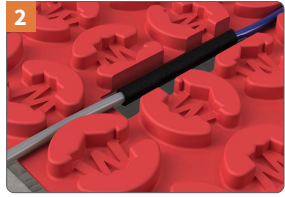

- Place the coldtail on the floor. Cut a section in the membrane for the manufactured joint so that it sits at the same height as the heater.
- Secure the cold tail using tabs of electrical tape as necessary. **DO NOT** tape over the manufactured joint or heating cable. These must be fully embedded within thinset or levelling compound being laid over.

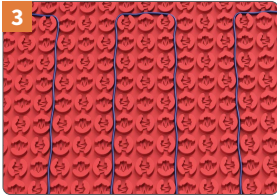

- Begin laying the heating cable, pressing it between the pegs.
- Follow the installation layout created in Step 5 to complete the cable placement.
- **DO NOT** install the heater in ambient temperatures less than 5 °F (-15 °C).

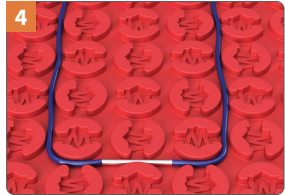

- The DCM-PRO cable has a marker at its midpoint. When you reach it, review your progress up to that point and check that you are correctly spacing the cable, ensuring that you will have covered the whole of the heated area when you reach the end of the cable.

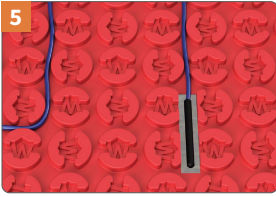

- At the end of the heating cable, you will find a termination joint. As with the manufactured joint at the beginning of the heating cable, this joint will have to be cut into the membrane so that it sits at the same height as the heater.
- **DO NOT** tape over the termination joint, it must be in direct contact and fully embedded within the thinset or levelling compound being laid over the heating cable.

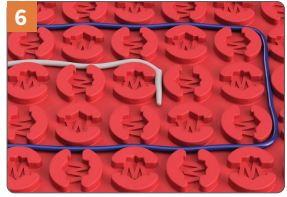

- Install the floor sensor at least 6" into the heated area it will be controlling. It should be located centrally between parallel runs of heating cable and not in an area influenced by other heat sources.
- If the heating cable is installed at multiple spacings, then the sensor should be installed centrally between the narrowest parallel run.

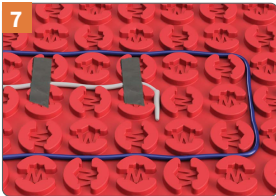

- Measure the resistance of the floor sensor and record it on the control card. If it's resistance is outside the prescribed range contact Warmup.
- **DO NOT** tape over the floor sensor tip it must be in full contact with the heated thinset or levelling compound.

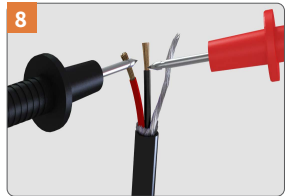

- Measure the resistance of the heating cable and verify it is still in line with the "Resistance Before" reading previously taken.
- Stop installation immediately and contact Warmup if its resistance has changed significantly or if it falls outside the range set out in the Reference Resistance Band table.

For floor finishes other than tiles a single layer of self levelling compound is required (**minimum thickness: $\frac{3}{8}$ " above the membrane**) over the heater which is suitable for use with underfloor heating and plastic underlayments. You must ensure the entire heater, including manufactured joints is encased in the levelling compound.

NOTE: Before installing the floor finish, its suitability for use with underfloor heating and its maximum operating temperature should be checked against required operating conditions.

Tiled/Stone Floor Finish

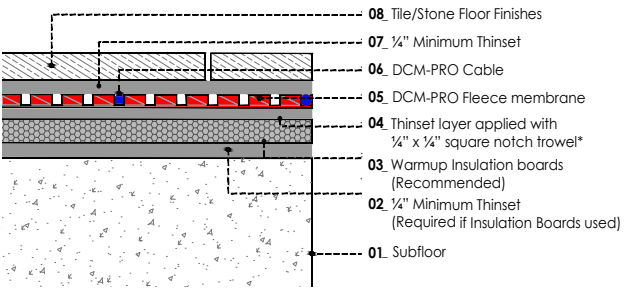

All Floor Finishes - With $\frac{3}{8}$ " Self Levelling Compound

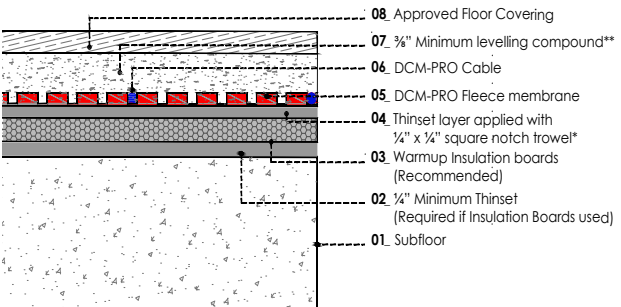

* Where required, prime the exposed surface in accordance with the thinset instructions. When installing DCM-PRO Peel and Stick membrane, the surface the membrane is being applied to must be primed and smooth such that a clean and continuous bond can be made. If necessary an appropriate $\frac{1}{8}$ " levelling compound should be applied. Coarse and/or loose subfloor surfaces will prevent the membrane from forming a continuous bond. For example; cement coated insulation boards with a raised pattern must have a levelling compound applied over.

**This method can be used to create a floor surface suitable for most floor finishes and when forming a drainage slope within a wetroom.



There are instances where waterproofing will be required, such as in wetrooms, where there will be significant exposure to water.

If using a proprietary waterproofing system, a levelling compound should first be laid over the Warmup DCM-PRO system to provide a finished surface to install over. Follow the steps below when using the Warmup DCM-PRO waterproofing products to waterproof the installation:

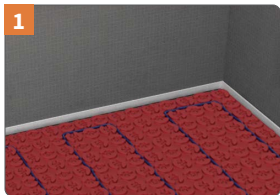

- 1 • Cut the perimeter strip to the same level as the DCM-PRO membrane.

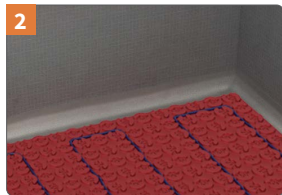

- 2 • Apply a suitable waterproof $\frac{3}{8}$ " layer of thinset to the membrane, walls and penetrations through the membrane, 4" either side of the joint, ensuring there are no gaps or voids.

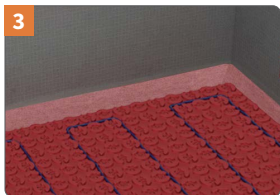

- 3 • Cut a length of Warmup waterproof tape to suit and press into the thinset along the wall perimeter using a trowel, removing any air gaps or creases.

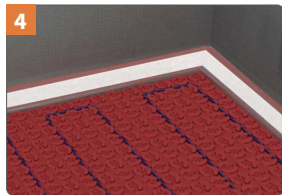

- 4 • Reapply the removed portion of the perimeter strip over the top of the Warmup waterproof tape flush with the floor.

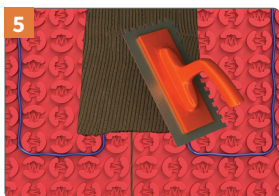

- To waterproof the joints between membrane runs and over the cable joints, apply a $\frac{3}{8}$ " layer of waterproof thinset, 4" either side of the joint, making sure the cavities of the membrane are fully filled.

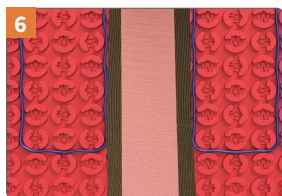

- Cut a length of Warmup waterproof tape to suit and press into the thinset using a trowel, removing any air gaps or creases taking care not to damage or dislodge the cable.

NOTE: Where joints are required, overlap the tape by 4" bonding the two lengths together with a layer of thinset.

NOTE: At the manufactured joint, the termination joint or anywhere that you have damaged or pierced the membrane, cover the penetration with a $\frac{3}{8}$ " layer of thinset and cover with Warmup waterproof tape.



Underfloor heating performs the most efficiently with conductive, low resistance floor finishes such as stone and tiles. The maximum thermal resistance of the floor must not exceed a thermal insulation "R" value of 1ft²·°F·h/Btu.

Tiled Floors



- Cover the installation with a minimum 1/4" full bed of modified thinset. Take care not to damage or dislodge the heating cable. If using tiles smaller than 3 1/2" in length or width, cover the installation with a levelling compound first.



- Carefully lay the tiles and press into the thinset.



- After laying the first tile remove and ensure the tile is getting a full coverage of thinset from your application.
- Ensure the width of the grout line is in line with the manufacturers instructions for the size and type of tile being used. Tiles must not be removed once the thinset has set, doing so will damage the heater.



- Grout the floor as soon as possible as per the ceramic thinset manufacturer's instructions. **DO NOT** switch on the heater until the thinset and grout has fully cured. **DO NOT** use the heater to accelerate the drying process of the thinset or levelling compound.

NOTE: If using tiles smaller than 3 1/2" in length or width, you **MUST** cover the installation with levelling compound first.

NOTE: Ensure that the thinset used is compatible with underfloor heating and suitable for application onto non porous materials such as the DCM-PRO membrane.

All Floor Finishes

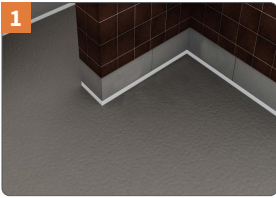

NOTE: Before installing the floor finish its suitability for use with underfloor heating and its maximum operating temperature should be checked against required operating conditions.

- If you are planning to install wood, carpet or vinyl over the heater a single layer of self levelling compound is required (**minimum thickness: $\frac{3}{8}$ " above the membrane**) over the heater. You must ensure that all heating cables are completely covered. It is important that the levelling compound is suitable for use with the DCM-PRO system.

Typical "R" Values:

Carpet $\frac{1}{2}$ " thick = 1.0 * Please check actual values with manufacturer
Stone & Ceramic $\frac{1}{2}$ " = 0.04 ,
Laminate $\frac{1}{4}$ " = 0.3
Engineered wood $\frac{3}{4}$ " = 0.75
Vinyl $\frac{1}{8}$ " = 0.1

Final Steps

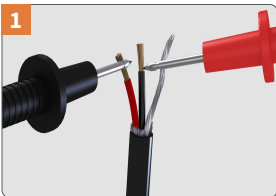

- When the tiles or levelling compound has been installed, conduct another resistance test to ensure the sensor and heater have not been damaged and record in the control card.
- Perimeter strips should be cut flush with the tiles or levelling compound using a utility knife.



Install the thermostat in accordance with its installation instructions

Instructions for fitting Warmup® Thermostats can be found inside the thermostat box. The UL/cUL certified thermostat must be connected to the main electrical supply via a fuse or circuit breaker in accordance with the National Electrical Code. If the thermostat used does not include a built-in Ground Fault Circuit Interrupter (GFCI), then one must be added to the circuit between the main power supply and the thermostat. If the thermostat does include a GFCI, it is NOT recommended to include another in the circuit, as this is likely to cause nuisance tripping of the GFCI's.

The total load of the heating cable(s) must not exceed the thermostat's limit or the amperage rating of the circuit or other control switch without using an appropriately rated contactor/relay. Warmup thermostats have a maximum resistive load rating of 15 Amps.

Ensuring Safety

Install the Warmup thermostat within the same room as the heating cables. In order to ensure the efficient running of the system within bathrooms, we recommend that the controls are located at least 60" away from shower openings or basin back splash areas so you minimize the possibility of exposure to water.

Typical Warmup Thermostat Wiring Diagram

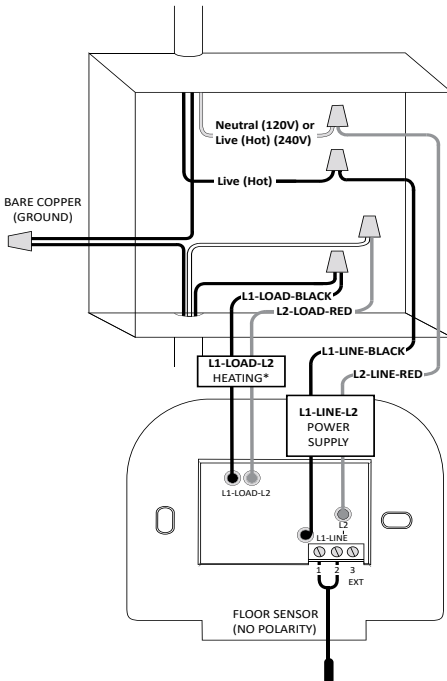

* Undertile heaters are to be installed in parallel across the load terminals of the thermostat or contactor and must not exceed their rated load.

HEATING ISSUE 1 - The floor does not heat up

Instructions which are shaded grey must be completed by a qualified electrician

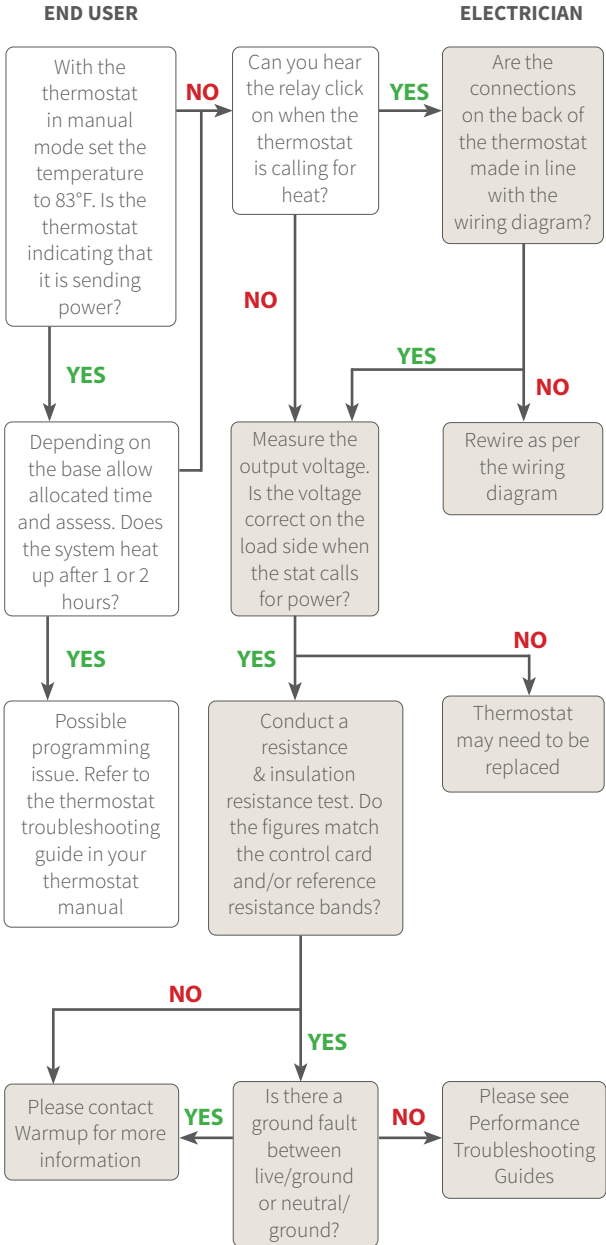



HEATING ISSUE 2 - The heater trips the GFCI

Instructions which are shaded grey must completed by a qualified electrician

ELECTRICIAN

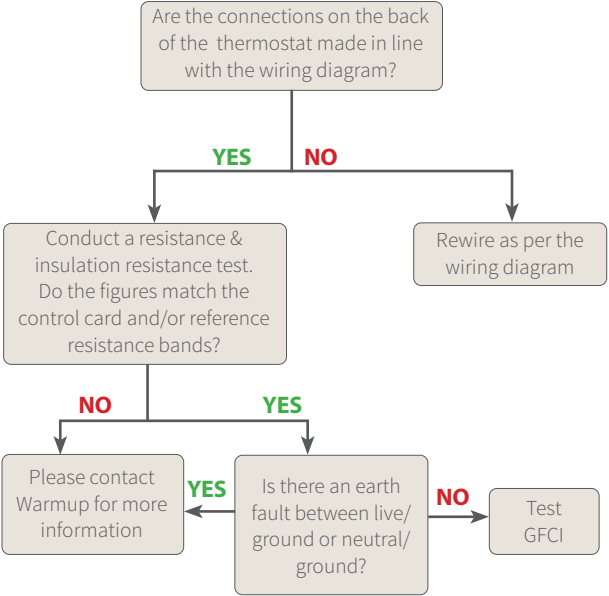

My floor is getting too hot

- 1. The floor temperature settings on the thermostat may be incorrect.**

Check the thermostat settings ensuring that it is controlling the floor surface temperature and that the set target and limiting temperatures are correct.

- 2. The floor sensor may be poorly positioned, if so the thermostat will be displaying a floor temperature that is not indicative of the floor surface temperature.**

Recalibrate the floor sensor in the thermostat settings.

- 3. The thermostat may be set in regulator mode with the duty cycle set too high.**

If the thermostat cannot be set to reference a floor sensor, reduce the regulation value to its minimum selectable value. With the heating active, incrementally increase the setting at an hourly interval until the required floor surface temperature is achieved.

My floor does not get up to temperature

- 1. Underfloor Heating is normally designed to heat floors to up to 16°F (9°C) above the design room air temperature, which is typically 84°F (29°C). Delicate floor finishes, such as vinyl and some wood floors, may be limited to 81°F (27°C). Our hand and foot temperature is normally similar to this, at around 84° - 90°F (29 - 32°C), so the heated floor will feel slightly cooler than touching your own hands together.**

If you wish to raise the floor temperature, such that it feels warm, it is permissible to set it up to 27°F (15°C) higher than the design room air temperature. The higher heat output of the floor may overheat the room, making it uncomfortable. The manufacturer of the floor finish should be consulted to ensure compatibility with the chosen temperature before making any changes to the thermostat settings.

- 2. Refer to points 1, 2 & 3 in the “My floor is getting too hot” above, as each issue can also be the cause of under heating a floor.**

- 3. If the thermostat is controlling the heating using the air temperature, with a floor temperature limit then the floor may be turned off before it reaches its limit.**

This is normal as the thermostat is preventing the room air temperature from becoming overheated.



My floor does not get up to temperature

4. The heating system may be uninsulated. If the heater has not been installed over a layer of Warmup Insulation Boards, it will be actively heating the subfloor as well as the floor finish. The warm up period of the floor will therefore be slower as the system is heating a much greater mass. It could take several hours if it is installed directly on a thick layer of uninsulated concrete.

If your thermostat has an optimised start feature, ensure it is enabled so that the thermostat can compensate for the mass of the floor. If your thermostat does not have an optimised start feature, measure the time taken for the floor to warm up and adjust the heating start time to compensate.

5. The heat output of the installed system may not be sufficient. The system will require a power output of approximately 0.93W/ft² (10W/m²) for every degree warmer you require the floor to be than the air. This is in addition to any heat loss downwards through the subfloor.

If the room air temperature is also lower than desired, supplementary heating may be required to overcome the room heat losses.

If access is available to the underside of the subfloor, installing insulation within the floor will reduce the amount of heat lost through the floor.

6. Floor coverings such as carpets, underlays and wood floors are thermally resistive and will reduce the achievable floor surface temperature. They may also require the floor sensor to be recalibrated.

Floor finish combinations with a thermal resistance of more than 1.5 tog are not recommended and we recommend that you look to fit a less resistive floor finish. Floor finish combinations with a thermal resistance of more than 2.5 tog are not permitted.

I am getting patchy heat across my floor

1. If the subfloor varies across the floor, the amount of heat absorbed by it and lost through it will affect the floor surface temperatures differently above each case.

2. If the floor covering over the underfloor heating changes, each floor finishes characteristics will affect the warm up period and the achievable surface temperature.

3. Hot water pipes under the floor could cause parts of the floor to seem warmer than others.

4. Irregularly spaced cables will cause the floor to be warmer above the closer cables and cooler where the cables are spaced further apart.

The heaters and floor sensors must be tested before they are laid, once they have been laid but before the tiles or levelling compound has been laid and again before they are connected to the thermostat. The resistance (ohms) of each heater should be measured. You should carry out the following tests and should expect the results detailed below:

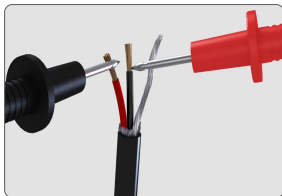

• Heating Cable Resistance Test

Set a multimeter or ohmmeter to record resistance in the range of 0-500 Ω . Measure the resistance across the RED-240V or YELLOW-120V wire and the black wire. Ensure the measured resistance is within the Reference Resistance Band shown in the Technical Specifications page for the cable size being tested.

Record the readings in the control card in line with the installation procedure.

• Earth Fault Check

Set a multimeter or ohmmeter to record resistance in the range of 200M Ω or greater if available. Measure the resistance across the RED-240V or YELLOW-120V wire and black wire to the ground (braid) wire.

Ensure the measured resistance is showing as greater than 200M Ω or infinite if the meter cannot read this high.

Insulation resistance test

Set an insulation resistance tester to 500VDC. Measure the resistance across the RED-240V or YELLOW-120V wire and black wire to the ground (braid) wire.

Ensure the measured resistance is showing greater than 200M Ω to indicate a pass.

NOTE: Due to the high resistance of the heating element, it may not be possible to get a continuity reading from the heating cable and as such, continuity testers are not recommended. When checking resistance, make sure your hands do not touch the meter's probes as the measurement will include your internal body resistance and render the measurement inaccurate. If you do not get the expected results or at any time you believe there may be a problem, please contact Warmup's Technical Team for guidance.

Floor Sensor

Ensure that the floor sensor is tested before the final floor finish has been laid. The floor sensor values can be found in the thermostat instructions. When testing the floor sensor ensure that the meter can read up to 20k Ω . Warmup thermostats use a 10k Ω floor sensor @ 77°F (25°C). For temperatures between 68°F (20°C) and 86°F (30°C) the resistance of the floor sensor should measure between 8k Ω and 12k Ω .



NOTE: Draw a plan showing the layout and location of the heating cable(s)

A large grid of graph paper, consisting of 20 columns and 30 rows of small squares, intended for drawing a layout plan.

Heater Location

.....

.....

Total Wattage

.....

WARNING

Radiant Floor Heating Systems - Risk of electric shock



Electric-wiring and heating panels contained within the floor. DO NOT penetrate with nails, screws, or similar devices. DO NOT restrict the thermal emission of the heated floor.

ATTENTION:

DO NOT cut or shorten the heating element.

Ensure that the entire heating element(s) including the joints are installed within the layer of thinset or levelling compound.

DO NOT tape over the joints or heating cable as this may insulate them, causing them to fail. The heating element must be used in conjunction with a GFCI.

Heater Model	Resistance Before	Resistance After	Insulation Resistance (Pass)	Floor sensor resistance

.....

Date

Signed

Company stamp/name

This form must be completed as part of the Warmup Guarantee. Ensure that the values are as per the instruction manual. Please register your warranty online by visiting warmup.com or warmup.ca

This card along with a plan showing the heater layout must be situated close to the consumer unit in a visible place.

Warmup Inc,

25-A Francis Clarke Circle, Bethel, CT 06801

T: +1 (888) 927-6333 F: (888) 927-4721 www.warmup.com

Warmup Canada

T: +1 (888) 592-7687 F: (888) 927-4721 www.warmup.ca





Please register your warranty online at warmup.com

WARMUP 30-YEAR WARRANTY



The NADCM-C Cable is guaranteed for 30 Years under floor covering which it is fitted when installed in combination with the DCM-PRO membrane except as provided below (and your attention is drawn to the exclusions listed at the end of this guarantee). If installed separately NADCM-C cable is guaranteed for 10 Years, the DCM-PRO membrane is guaranteed for 5 Years.

THE WARMUP 30-YEAR WARRANTY DOES NOT EXTEND TO THERMOSTATS, WHICH ARE COVERED BY A THREE-YEAR GUARANTEE FROM THE DATE OF ORIGINAL PURCHASE.

GOVERNING LAW: unless otherwise governed by applicable state law, this warranty shall be interpreted and enforced in accordance with the laws of the State of Connecticut.

This 30-Year Warranty applies:

1. From the date of original purchase, only if the heater is registered with Warmup within thirty (30) days after the date of purchase; and
2. Proof of purchase is presented to Warmup i.e. invoice and receipt. Such invoice and receipt must state the exact model that was purchased; and
3. The control card accompanying this warranty is complete and presented to Warmup for inspection; and
4. The floor covering under which the heater(s) was originally installed, remains undisturbed and in situ; and
5. The heater has been grounded and protected by a ground fault circuit interrupter (GFCI) at all times during the heaters operation

COVERAGE

1. The warranty period begins on the date of purchase. Registration is effective only when a letter of confirmation is sent by Warmup, Inc.
2. Warmup's Undertile Heater is guaranteed by WARMUP, INC. ("Warmup") to be free from defects in materials and workmanship under normal use and maintenance for thirty (30) years, provided the Product is installed in accordance with the accompanying Warmup installation manual, any special written design or installation guidelines by Warmup, Inc. for a particular project, the National Electrical Code (NEC), the Canadian Electrical Code (CEC), and all applicable local building and electrical codes; and
3. During the period of Warranty, Warmup will arrange for the heater to be repaired or (at its discretion) have parts replaced free of charge. The costs of repair or replacements are your only remedy under this Warranty. Such cost does not extend to any cost other than direct cost of repair or replacement by Warmup and does not extend to costs of relaying, replacing or repairing any floor covering or floor.
4. If Warmup, Inc. determines the repair of the product is not feasible; we will replace the product with equal or similar features and functionality at Warmup's sole discretion. WARMUP'S MAXIMUM LIABILITY IS LIMITED TO THE ORIGINAL PURCHASE PRICE OF THE HEATER MULTIPLIED BY THE PERCENTAGE OF THE WARRANTY PERIOD REMAINING.

EXCLUSIONS

Warmup, Inc. shall in no event be liable for incidental or consequential damages, including but not limited to extra utility expenses or damages to property.

This Warranty is null and void if

1. The floor covering over the heater(s) is damaged, lifted, replaced, repaired or covered with subsequent layers of flooring.
2. The heater fails due to damage caused during installation of the final floor finish, unless damage is caused directly by an employee of Warmup. It is therefore essential to check that the heater is working (as specified in the installation manual) prior to tiling.

3. Damage as a result of floods, fires, winds, lightning, accidents, corrosive atmosphere or other conditions beyond the control of Warmup, Inc.
4. Use of components or accessories not compatible with Warmup heaters
5. Warmup products installed outside the United States or Canada.
6. Parts not supplied or designated by Warmup, Inc.
7. Damage or repair required as a result of any improper use, maintenance, operation or servicing.
8. Failure to start due to interruption and/or inadequate electrical service
9. Any damage caused by frozen or broken water pipes in the event of equipment failure.
10. Changes in the appearance of the product that does not affect its performance.
11. The owner, or his/her designated representative, attempts to repair the product without receiving prior authorization from Warmup. Upon notification of a repair problem, Warmup, Inc. will issue an Authorization to Proceed under the terms of this Warranty.

If Warmup is required to inspect or repair any defects caused by any exclusions referenced above, all work will be fully chargeable at Warmup's inspection and repair rates then in effect.

WARMUP, INC. DISCLAIMS ANY WARRANTY NOT PROVIDED HEREIN, INCLUDING ANY IMPLIED WARRANTY OF THE MERCHANTABILITY OR IMPLIED WARRANTY OF FITNESS FOR A PARTICULAR PURPOSE. WARMUP, INC. FURTHER DISCLAIMS ANY RESPONSIBILITY FOR SPECIAL, INDIRECT, SECONDARY, INCIDENTAL, OR CONSEQUENTIAL DAMAGES ARISING FROM OWNERSHIP OR USE OF THIS PRODUCT, INCLUDING INCONVENIENCE OR LOSS OF USE. THERE ARE NO WARRANTIES THAT EXTEND BEYOND THE FACE OF THIS DOCUMENT. NO AGENT OR REPRESENTATIVE OF WARMUP, INC. HAS ANY AUTHORITY TO EXTEND OR MODIFY THIS WARRANTY UNLESS SUCH EXTENSION OR MODIFICATION IS MADE IN WRITING BY A CORPORATE OFFICER. DUE TO DIFFERENCES IN BUILDING AND FLOOR INSULATION, CLIMATE AND FLOOR COVERINGS, WARMUP, INC. MAKES NO REPRESENTATION THAT THE FLOOR TEMPERATURE WILL ACHIEVE ANY PARTICULAR TEMPERATURE OR TEMPERATURE RISE. UL STANDARD LISTING REQUIREMENTS LIMIT THE HEAT OUTPUT OF WARMUP UNDERTILE HEATING, AS SUCH, USERS MAY OR MAY NOT BE SATISFIED WITH THE FLOOR WARMTH THAT IS PRODUCED. WARMUP DOES WARRANT THAT ALL HEATERS WILL PRODUCE THE RATED WATT OUTPUT LISTED ON THE HEATER NAMEPLATE, WHEN OPERATED AT THE RATED VOLTAGE.

TERMS AND CONDITIONS

Shipping Discrepancies:

Incoming materials should be inventoried for completeness and for possible shipping damage. Any visible damages or shortages must be noted prior to accepting the material. Any discrepancy concerning type or quantity of material shipped, must be brought to the attention of your Warmup® reseller within 15 days of the shipping date entered on the packing slip for the order.

Miscellaneous:

The terms of this Limited Warranty are exclusive and supercede any other warranty or terms and conditions relating to the subject matter whether included in a purchase order for this product or in any other document or statement.



TECHNICAL SPECIFICATIONS - DCM-PRO MEMBRANE				
THICKNESS	1/4"			
COMPOSITION	DCM-PRO Fleece membrane: POLYPROPYLENE MEMBRANE WITH FLEECE BACKING DCM-PRO Peel and Stick membrane: POLYPROPYLENE MEMBRANE WITH SELF-ADHESIVE BACKING			
COLOR	RED			
SPACING	3 5/8" & 4 7/8"			
SIZE	Fleece	2'3" x 3'3" sheet 46'7" x 3'3" roll	Peel & Stick	2'6" x 3'3" sheet 46'7" x 3'3" roll

TECHNICAL SPECIFICATIONS - DCM-PRO CABLE	
OPERATING VOLTAGE	120 V and 240 V: 60Hz
COLOR	BLUE
THICKNESS	3/16"
OUTPUT RATING	~13 W/ft ² (3 PEG - 3 5/8")
INNER INSULATION	ECTFE
OUTER INSULATION	PVC
MIN. TEMPERATURE INSTALLATION	5°F (-15°C)
CONNECTION	10ft (3m) "COLDTAIL" CONNECTION
NADCM-C cable is suitable for wet locations "Type W"	

TECHNICAL SPECIFICATIONS - PERIMETER STRIP	
COMPOSITION	SELF-ADHESIVE BACKED POLYETHYLENE FOAM STRIP
SIZE	82ft roll x (H) 1 1/8" x (T) 3/8"

Certifications

Warmup NADCM-C cable

Warmup NADCM-C heating cables are UL certified or listed to the following standards and usage:

- UL 1683 "Electric Heating Products For Installation Under Floor Coverings".
- CAN/CSA-C22.2 No. 130-16 "Requirements for Electrical Resistance Trace Heating and Heating Device Sets".

Where peg spacings of 3, 3-4 and 4 are used, the UL certification applies to the entire system, including the membrane. For UL-Approved manual please visit warmup.com.

Warmup DCM-PRO membrane is tested to the following standards:

Tile Council of North America

- ANSI A118.12: "Specification for Crack Isolation Membranes for Thin-Set Ceramic Tile and Dimension Stone Installation"
- ASTM C627: "A Standard Test Method for Evaluating Ceramic Floor Tile Installation Systems Using the Robinson-Type Floor Tester"

Warmup Thermostats - are tested to the following standards:

- Automatic Electrical Controls - Part 1: General Requirements [UL 60730-1]; [CSA E60730-1];
- UL Standard For Safety For Automatic Electrical Controls For Household And Similar Use - Part 2-9: Particular Requirements For Temperature Sensing Controls [UL 60730-2-9]; [CSA E60730-2-9];
- Ground-Fault Circuit-Interrupters [UL 943]; [CSA C22.2#144.1]

Cable size guide

NADCM-C Cable						REFERENCE RESISTANCE BANDS (Ω)
PRODUCT CODE	Heated Area (ft ²)	Power (W)	Load (A)	Resistance (Ω)		
120 VOLT	NADCM-C-120-65	5	65	0.5	221.5	210.4 - 232.6
	NADCM-C-120-130	10	130	1.1	110.8	105.3 - 116.3
	NADCM-C-120-195	15	195	1.6	73.8	70.1 - 77.5
	NADCM-C-120-260	20	260	2.2	55.4	52.6 - 58.2
	NADCM-C-120-325	25	325	2.7	44.3	42.1 - 46.5
	NADCM-C-120-390	30	390	3.3	36.9	35.1 - 38.7
	NADCM-C-120-525	40	525	4.4	27.4	26.0 - 28.8
	NADCM-C-120-655	50	655	5.5	22.0	20.9 - 23.1
	NADCM-C-120-785	60	785	6.5	18.3	17.4 - 19.2
	NADCM-C-120-920	70	920	7.7	15.6	14.8 - 16.4
	NADCM-C-120-1050	80	1050	8.8	13.7	13.0 - 14.4
	NADCM-C-120-1180	90	1180	9.8	12.2	11.6 - 12.8
	NADCM-C-120-1315	100	1315	11.0	11.0	10.5 - 11.6
	NADCM-C-120-1445	110	1445	12.0	10.0	9.5 - 11.5
	NADCM-C-120-1575	120	1575	13.1	9.1	8.6 - 9.6
240 VOLT	NADCM-C-240-195	15	195	0.8	295.4	280.6 - 310.2
	NADCM-C-240-325	25	325	1.4	177.2	168.3 - 186.1
	NADCM-C-240-390	30	390	1.6	147.7	140.3 - 155.1
	NADCM-C-240-525	40	525	2.2	109.7	104.2 - 115.2
	NADCM-C-240-655	50	655	2.7	87.9	83.5 - 92.3
	NADCM-C-240-785	60	785	3.3	73.4	69.7 - 77.1
	NADCM-C-240-920	70	920	3.8	62.6	59.5 - 65.7
	NADCM-C-240-1050	80	1050	4.4	54.9	52.2 - 57.6
	NADCM-C-240-1180	90	1180	4.9	48.8	46.4 - 51.2
	NADCM-C-240-1310	100	1310	5.5	44	41.8 - 46.2
	NADCM-C-240-1640	125	1640	6.8	35.1	33.3 - 36.9
	NADCM-C-240-1970	150	1970	8.2	29.2	27.7 - 30.7
	NADCM-C-240-2300	175	2300	9.6	25.0	23.8 - 26.3
	NADCM-C-240-2630	200	2630	11.0	21.9	20.8 - 23.0
	NADCM-C-240-2955	224	2955	12.3	19.5	18.5 - 20.5
NADCM-C-240-3240	249	3240	13.5	17.8	16.9 - 18.7	

NOTE: Warmup thermostats use a 10kΩ floor sensor. The expected resistance is:

- 10 kΩ at 77°F (25°C),
- 12.1 kΩ at 68°F (20°C),
- 14.7 kΩ at 59°F (15°C).

Warmup Inc

25-A Francis Clarke Circle, Bethel,
CT 06801

W: www.warmup.com

E: us@warmup.com

T: (888) 927-6333

F: (888) 927-4721

W: www.warmup.ca

T: (888) 592-7687

F: (888) 927-4721

The WARMUP word and associated logos are trade marks.

© Warmup Inc. 2023 – Regd. TM Nos. 1257724, 4409934, 4409926,
5265707. E & OE.



Electric
Heating System

www.warmup.com
www.warmup.ca